

Article number: 0118022

Description: Retaining ring H 9

Measures

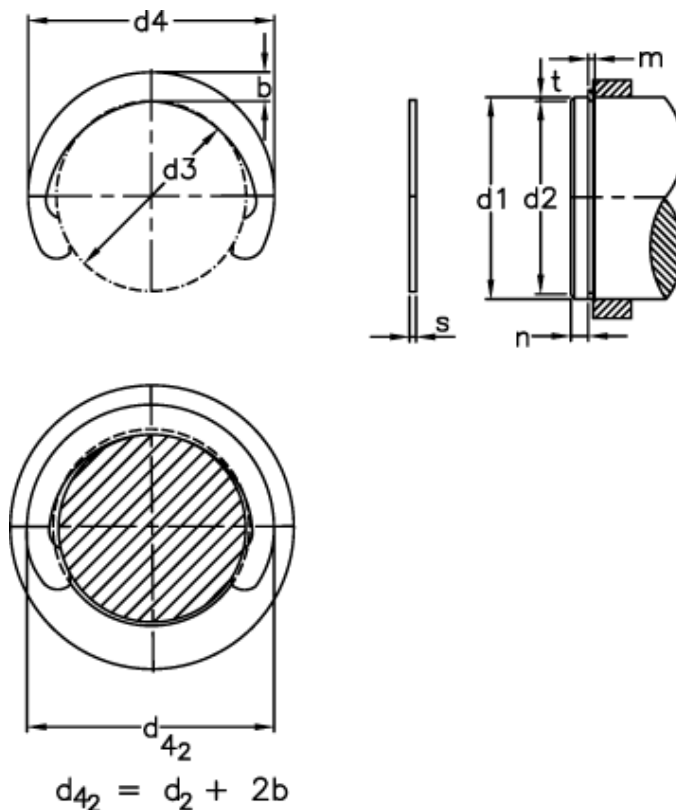

b	= 1.70	FRg kN	= 2.0	t	= 0.50
d1	= 9	FR kN	= 3.50	tol	= -0.09
d2	= 8.0	g	= 1.00	tol	= 0.09
d3	= 7.80	Gripper	= GRH 9	tol	= -0.06
d4	= 11.20	m min	= 1.10	Weight kg/1000	= 0.22
d4 2	= 11.4	n abl x 1000	= 58		
Description	= H 9,0	Nominal drive	= 1.5		
FN kN	= 1.10	s	= 1.00		